

ME 4710 Motion and Control

Closed Loop Hydraulic Positioning System

Introduction

Fig. 1 shows the *block diagram* of a basic *closed-loop, hydraulic actuation system*. The system consists of a *linear proportional control valve*, a *hydraulic cylinder*, and a *proportional controller*. The transfer functions $G_v(s)$ and $G_{cyl}(s)$ represent the *valve* and *cylinder dynamics*, respectively. The *input* to the system ($R(s)$) can represent the *desired speed* or *position* of the cylinder, and the *output* ($Y(s)$) can represent the *actual speed* or *position* of the cylinder.

Linear proportional valves are probably better suited for controlling the *velocity* of a hydraulic cylinder because of *dead-band* associated with the valve spool position. However, in the example that follows, a linear proportional valve is used to control the position of a hydraulic cylinder.

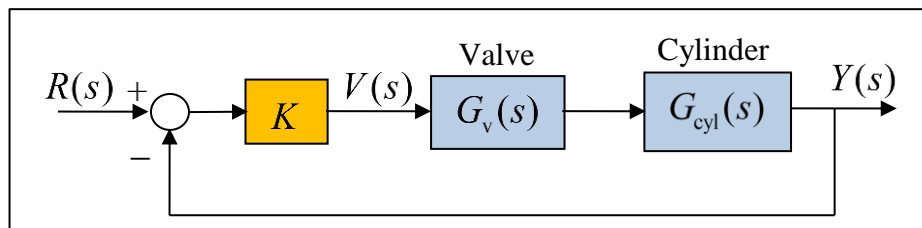

Fig. 1. Block Diagram of a Closed-Loop Hydraulic Actuation System

To understand the response of the closed-loop system, start by analyzing the open loop system shown in Fig. 2. Unfortunately, measurements of this system show the transfer functions $G_v(s)$ and $G_{cyl}(s)$ both depend on the magnitude of the input voltage $V(s)$. In short, the system is *non-linear*. Analysis of this system is further complicated by *voltage limits* on the valve. The valves, for example, can have an input voltage limit of ± 10 volts.

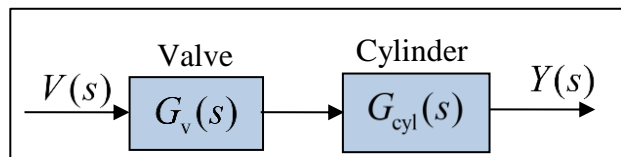

Fig. 2. Block Diagram of an Open-Loop Hydraulic Actuation System

It should be noted that, even though the transfer functions $G_v(s)$ and $G_{cyl}(s)$ do change as the input voltage $V(s)$ changes, the *form* of the transfer functions *does not change*. In fact, for some range of voltages, the *transfer functions are similar*. For example, transfer functions calculated

for a 5-volt command tend to provide reasonable predictions of the cylinder position response for a 7-volt command.

Root Locus Analysis of Closed Loop System

To get an initial estimate of what proportional gain K could be used for the closed loop system, the transfer functions derived from the 5-volt data will be used. This should be a good representation of the system at larger voltages. In this case, the loop transfer function is

$$GH(s) = \frac{116303}{s(s + 27.864)(s^2 + 127.83s + 10417)} \quad (1)$$

The *root locus diagram* shown in Fig. 3 indicates the system will be *stable* for $0 < K < 190$ and the two slowest poles will be *critically damped* for $K \approx 15$.

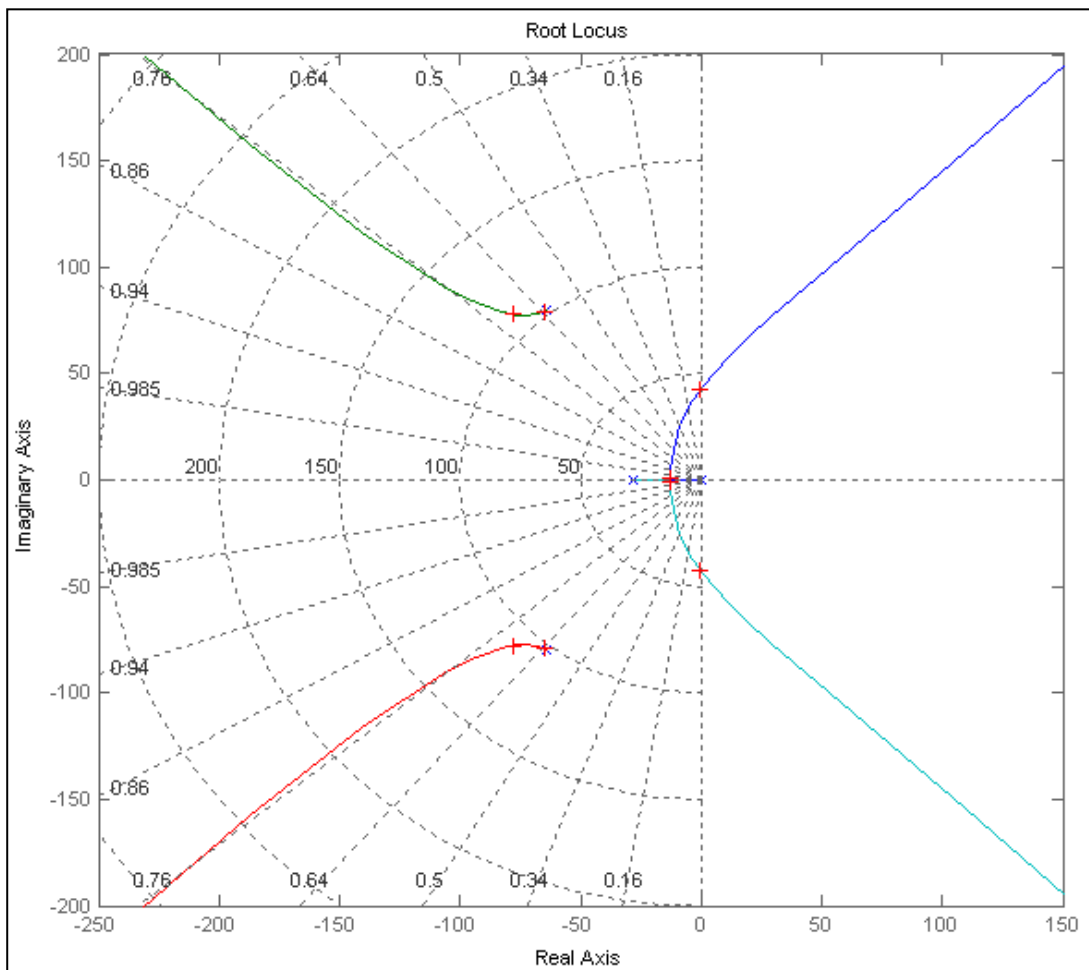

Fig. 3. Root Locus Diagram for Hydraulic Actuation System of Eq. (1)

Simulation of the Closed Loop System

Fig. 4 shows a *Simulink model* of the closed loop hydraulic actuation system. As in the root locus analysis, the valve and cylinder transfer functions were derived from the 5-volt data. The model assumes these transfer functions apply for all voltages, and in this sense, it is a *linear* model. However, the model also includes the *non-linear* effects of *saturation* and *dead-band*. The *command* to the *valve* and the *valve spool position* are both forced to be in the range of ± 10 volts (saturation), and for small commands it is assumed to have no response (dead-band).

The code sends the calculated data for *valve command*, *valve response*, *cylinder speed*, and *cylinder position* to the MATLAB workspace for later plotting and analysis.

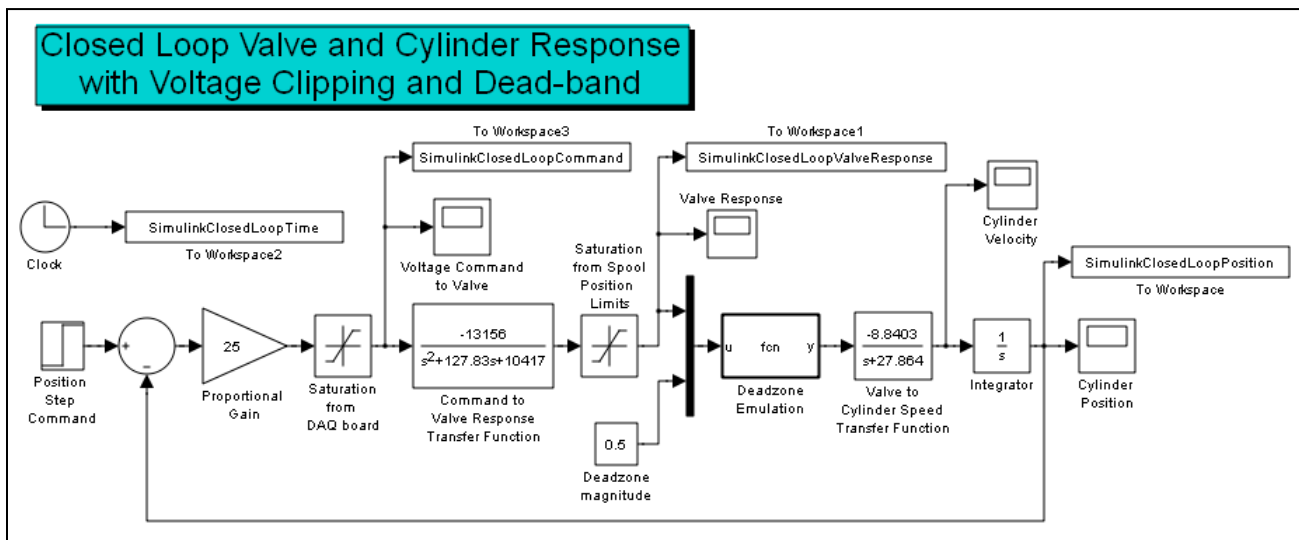

Fig. 4. Simulink Model of Closed Loop Hydraulic Actuation System

Fig. 5 shows the *model* and *test results* using a proportional gain of $K = 25$, *saturation limits* of ± 10 volts, and a *dead-band* of ± 0.5 volts. Note the *valve command* is *saturated* for about the first 1.8 seconds of the run forcing the cylinder to run at *maximum speed* until it is close to the final value. At that point the *valve command* quickly *decreases* to its *minimum value*. Note that when the command gets within the *dead-band*, the cylinder velocity goes to zero. As a result, the final position of the cylinder may exhibit a steady-state error.

The “closed-loop” system behaves like an “open-loop” system for about the first 1.8 seconds of the response. After that time, as the command reduces to its lowest value, the system behaves as a closed-loop system. Because the transfer functions will vary with command magnitude, the actual system will not have this exact response.

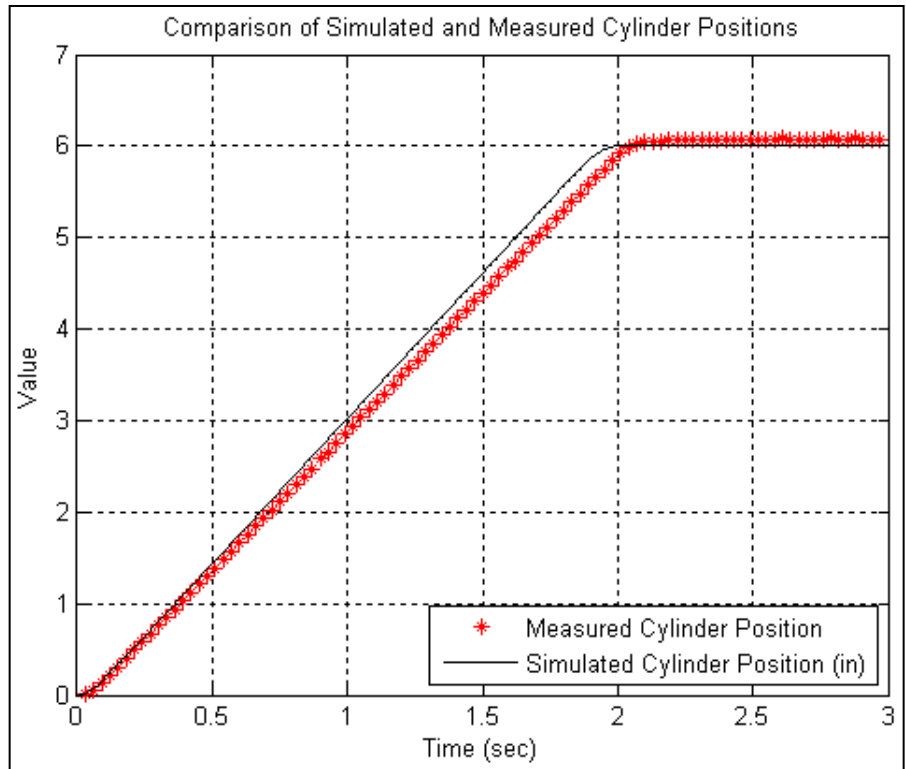

Fig. 5. Closed Loop Cylinder Step Response (6-inch step)

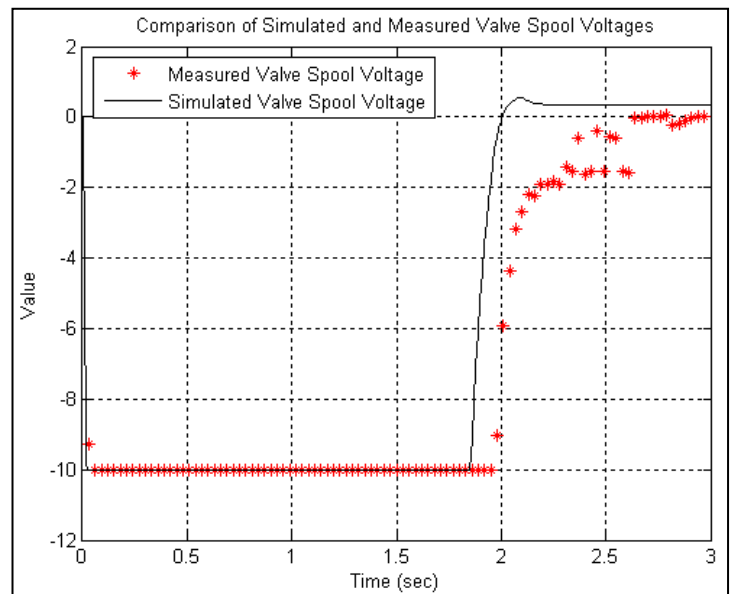
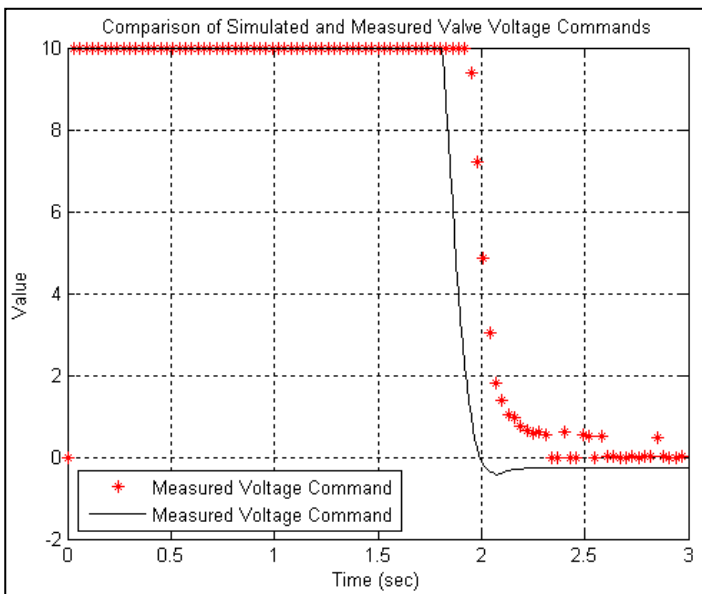

Fig. 6. Closed-loop Valve Command and Spool Responses